

目 录

一、运输作业组织与管理模块..... 2

二、仓储与配送作业组织与管理模块..... 34

三、国际物流作业组织与管理模块..... 150

四、 快递物流作业组织与管理模块.....	213
-----------------------	-----

湖南商务职业技术学院物流管理专业学生技能考核题库

一、运输作业组织与管理模块

○

○

○

--	--	--

○

○

--	--	--	--	--

() 任务描述

- :
-
-



<input type="checkbox"/> <input type="checkbox"/>				<input type="checkbox"/> <input type="checkbox"/>				
<input type="checkbox"/> <input type="checkbox"/>								
						<input type="checkbox"/> <input type="checkbox"/> <input type="checkbox"/> <input type="checkbox"/>		



() 任务描述:

-
-
-



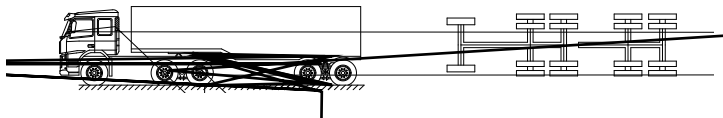
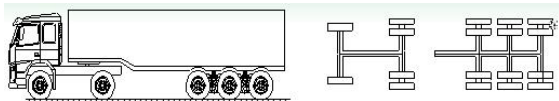

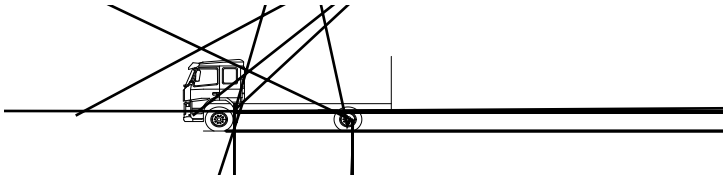
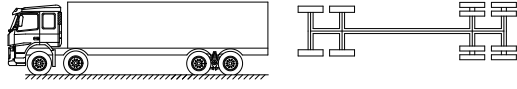
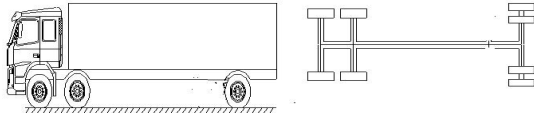

() 任务描述:

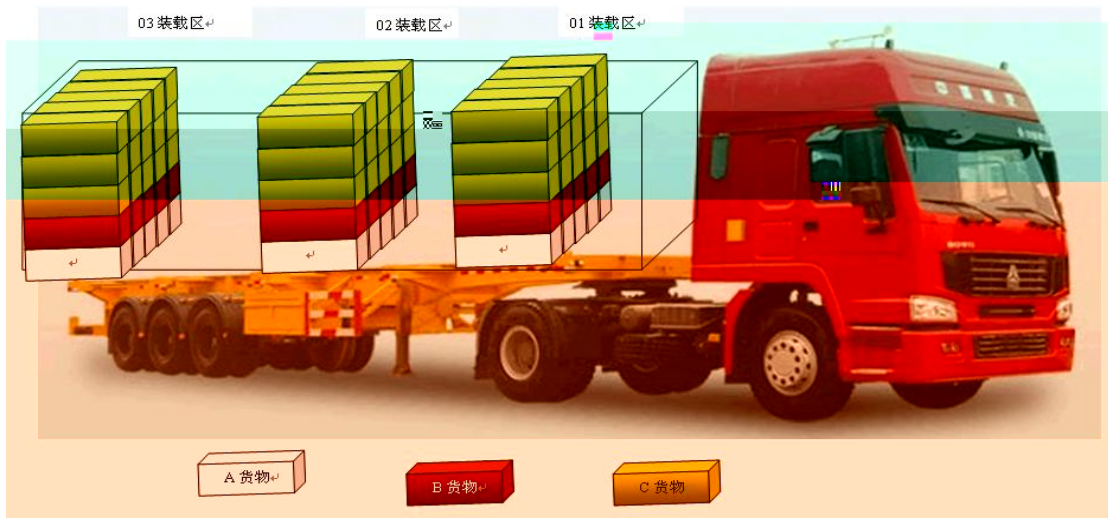

○

○

○

○

○

() 任务描述



D

<input type="checkbox"/> <input type="checkbox"/>			<input type="checkbox"/> <input type="checkbox"/>						
<input type="checkbox"/> <input type="checkbox"/>									
						<input type="checkbox"/> <input type="checkbox"/> <input type="checkbox"/> <input type="checkbox"/>			



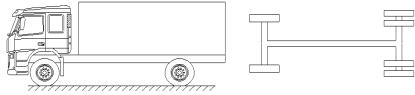
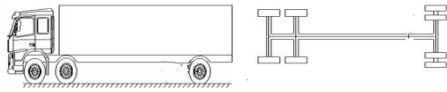
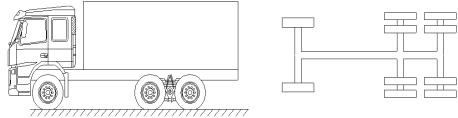

2

3

4

() 任务描述



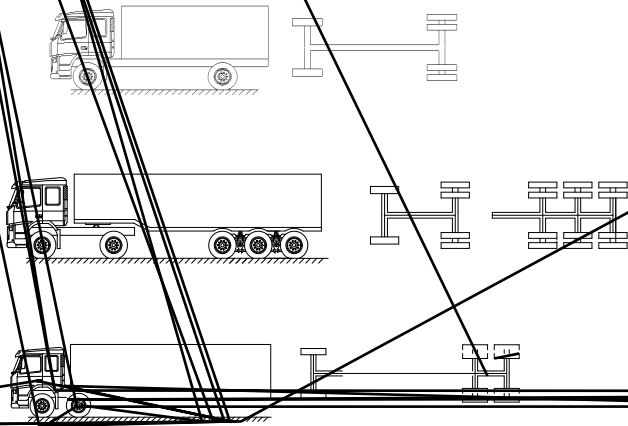



() 任务描述

-
-
-
-
-

() 任务描述

○

Sailing Schedule from : Shenzhen,Shenzhen,Guangdong,China

To : Los Angeles,Los Angeles,CA,United States

Origin City : Shenzhen,Shenzhen,Guangdong,China

Destination City : Los Angeles,Los Angeles,CA,United States

CY/DOOR

CY/DOOR

序列号	航线	船名	航次	截关时间	装货港	预计离港时间	实际离港时间	卸货港
1	YPSW	YM UNISON	59E	2016-04-22 17:00	Yantian	2016-04-25		Los Angeles
2	SEA	NORTHERN JAVELIN	002E	2016-04-23 12:00	Yantian	2016-04-27		Long Beach
3	AAS2	CMA CGM LIBRA	095TXE	2016-04-25 16:00	Yantian	2016-04-28		Long Beach
4	YPSW	YM UBIQUITY	22E	2016-04-29 17:00	Yantian	2016-05-02		Los Angeles
5	SEA	C SCL PUSAN	117E	2016-04-30 12:00	Yantian	2016-05-04		Long Beach
6	AAS2	CMA CGM COLUMBA	097TXE	2016-05-02 16:00	Yantian	2016-05-05		Long Beach
7	SEA	COSCO NINGBO	069W	2016-05-06 11:00	Yantian	2016-05-08		Long Beach
8	YPSW	YM JIREBY	50E	2016-05-06 17:00	Yantian	2016-05-09		Los Angeles
9	SEA	COSCO EXCELLENCE	027E	2016-05-07 12:00	Yantian	2016-05-11		Long Beach
10	AAS2	CMA CGM CENTAURUS	099TXE	2016-05-09 16:00	Yantian	2016-05-12		Long Beach
11	YPSW	YM MASCULINITY	32E	2016-05-13 17:00	Yantian	2016-05-16		Los Angeles
12	SEA	HONG KONG BRIDGE	039E	2016-05-14 12:00	Yantian	2016-05-18		Long Beach
13	AAS2	CMA CGM THALASSA	101TXE	2016-05-16 16:00	Yantian	2016-05-19		Long Beach



干货箱



	箱体内部尺寸			箱体内容积及载重量		箱门开度尺寸	
	L	W	H	Cu	P	W	H
20'	5898	2352	2393	33.2	21740/28230#	2340	2280
40'	12032	2352	2393	67.7	26630	2340	2280
HC	12032	2352	2698	76.3	26520	2340	2585

冷藏箱



	箱体内部尺寸			箱体内容积及载重量	
	L	W	H	Cu	P
20'	5444	2284	2267	28.5	21135/27160#
40'	11583	2284	2250	58.7	26580
HC	11583	2284	2659	67.9	26380

开顶箱

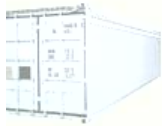

	箱体内部尺寸			箱体内容积及载重量	
	L	W	H	Cu	P
20'	5900	2330	2337	32.6	21740
40'	12025	2330	2337	65.8	26410

○

○

() 实施条件

() 考核时量

() 评分细则

1

() 任务描述



		<input type="checkbox"/>	<input type="checkbox"/>	<input type="checkbox"/>	<input type="checkbox"/>

<input type="checkbox"/> <input type="checkbox"/> <input type="checkbox"/> <input type="checkbox"/>							



() 实施条件

() 考核时量

() 评分细则

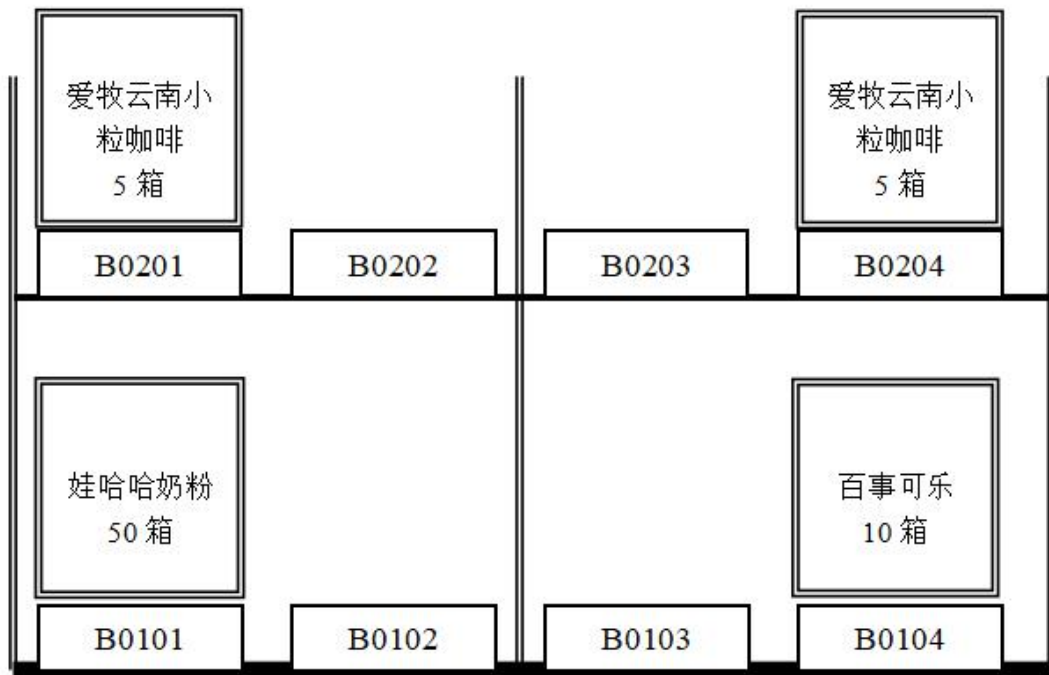
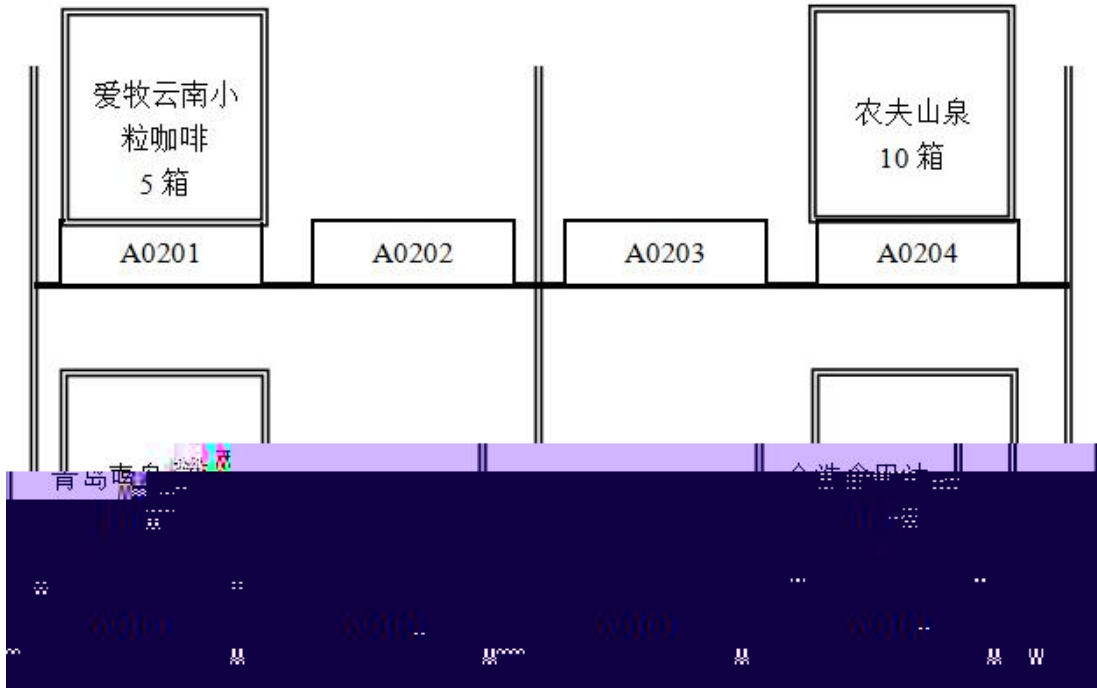

产品运输单

-
-
-
-
-
-
-
-

80				

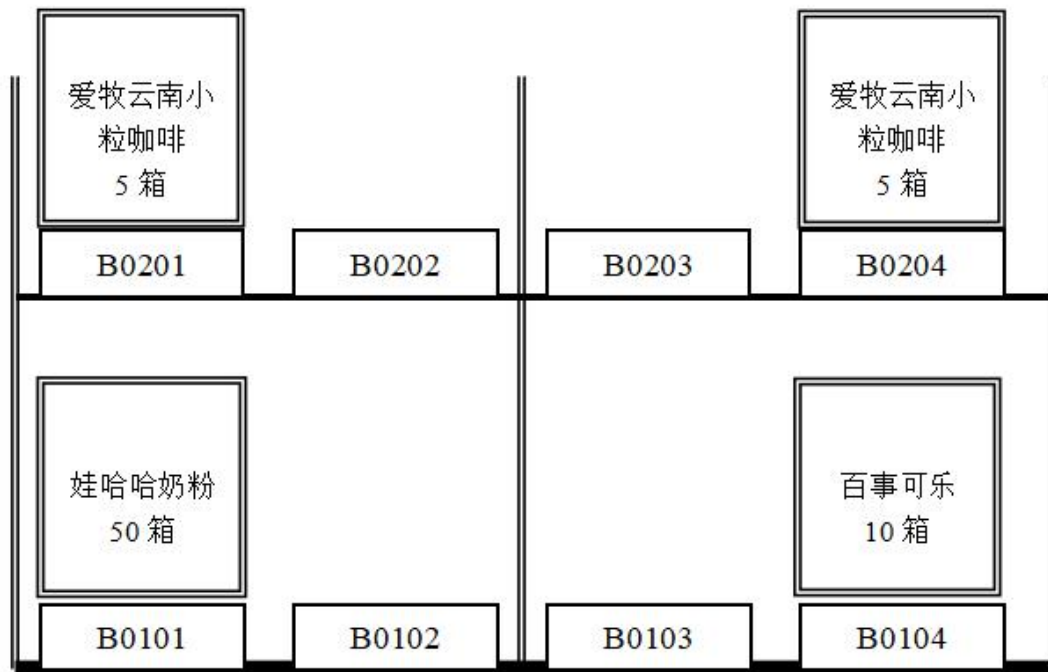
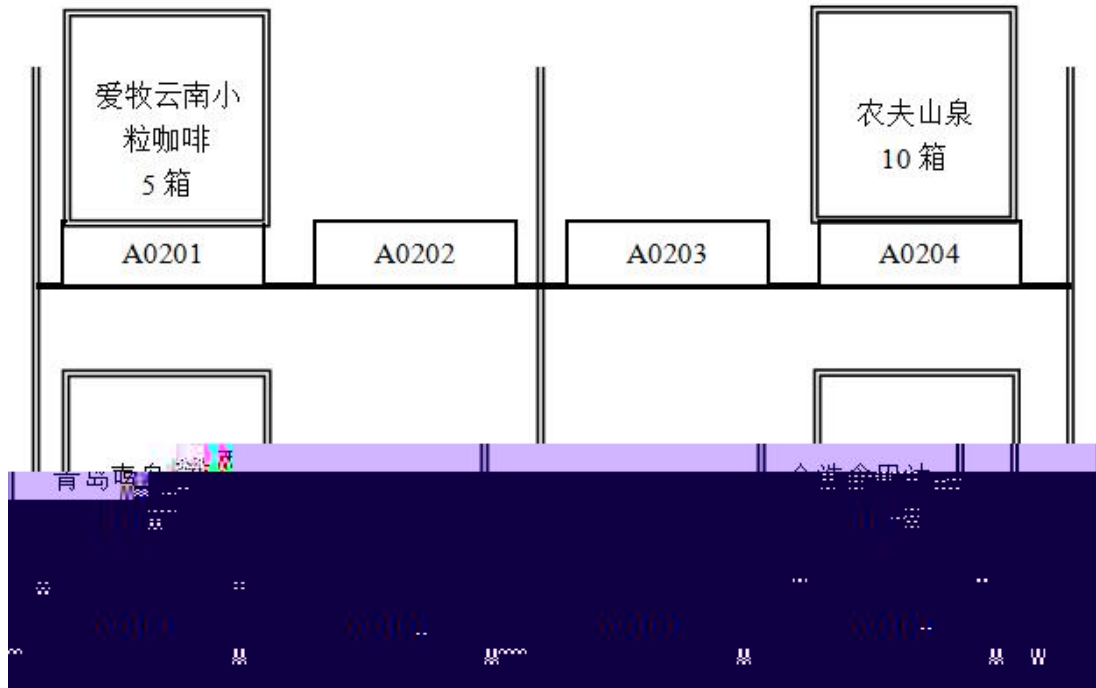

产品运输单

-
-
-
-
-
-
-
-

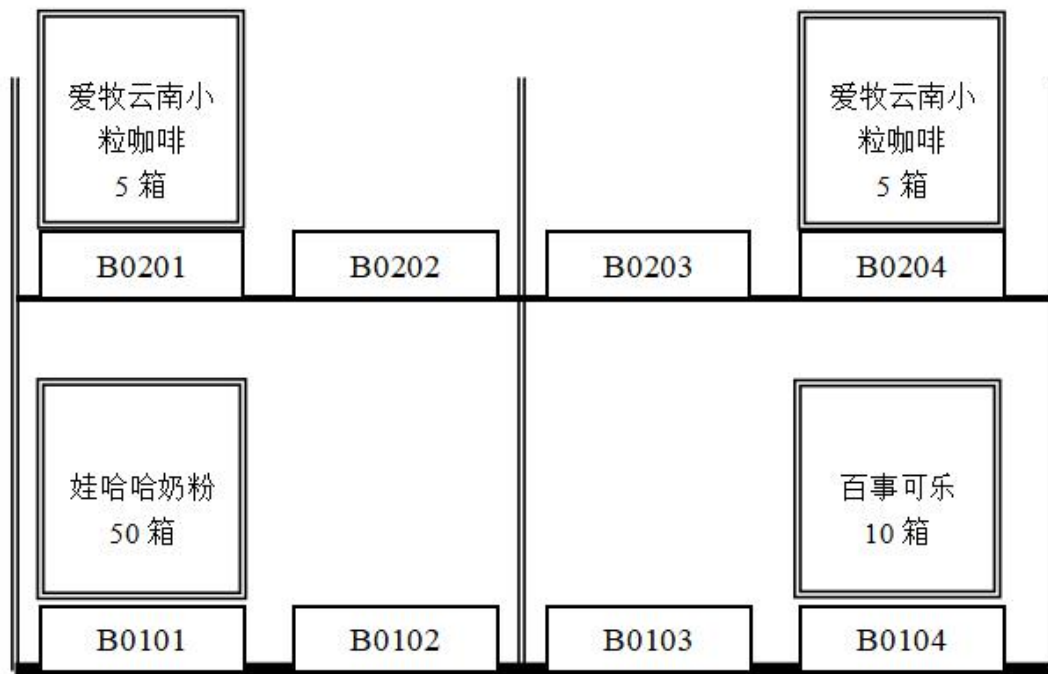
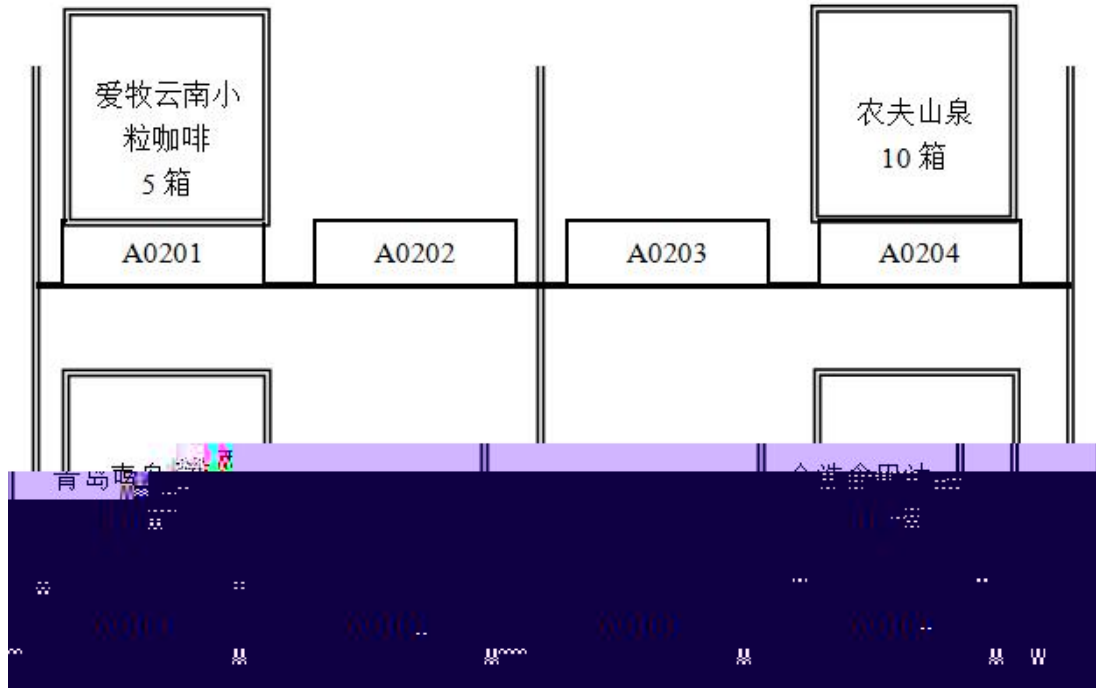

产品运输单

-
-
-
-
-
-
-
-

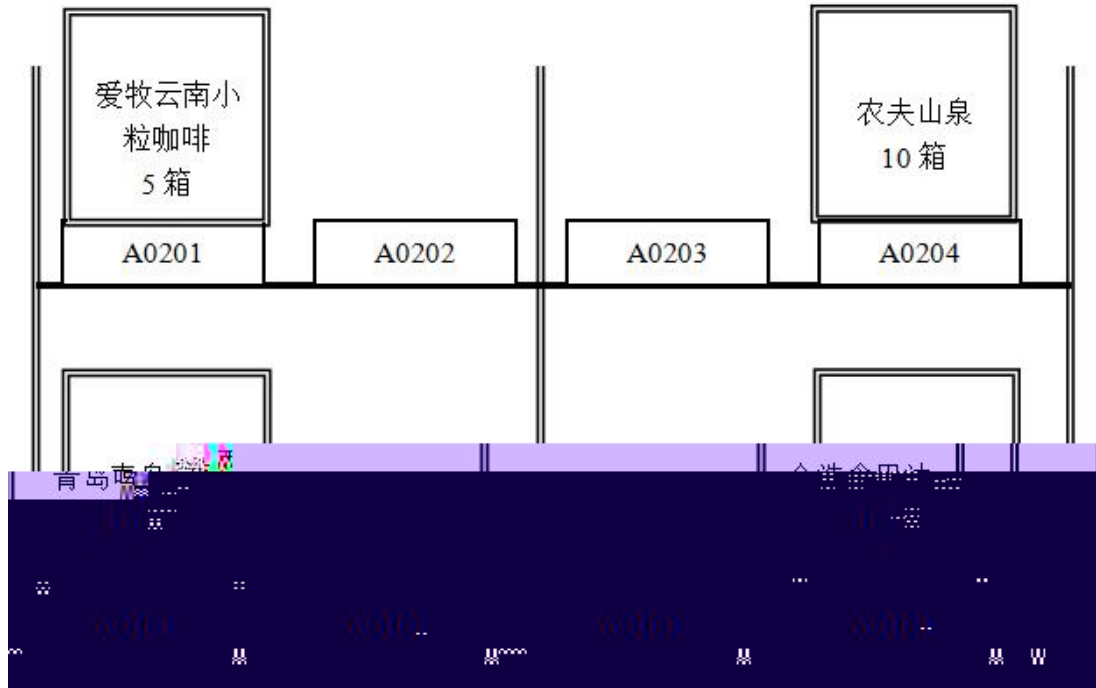

产品运输单

-
-
-
-
-
-
-
-

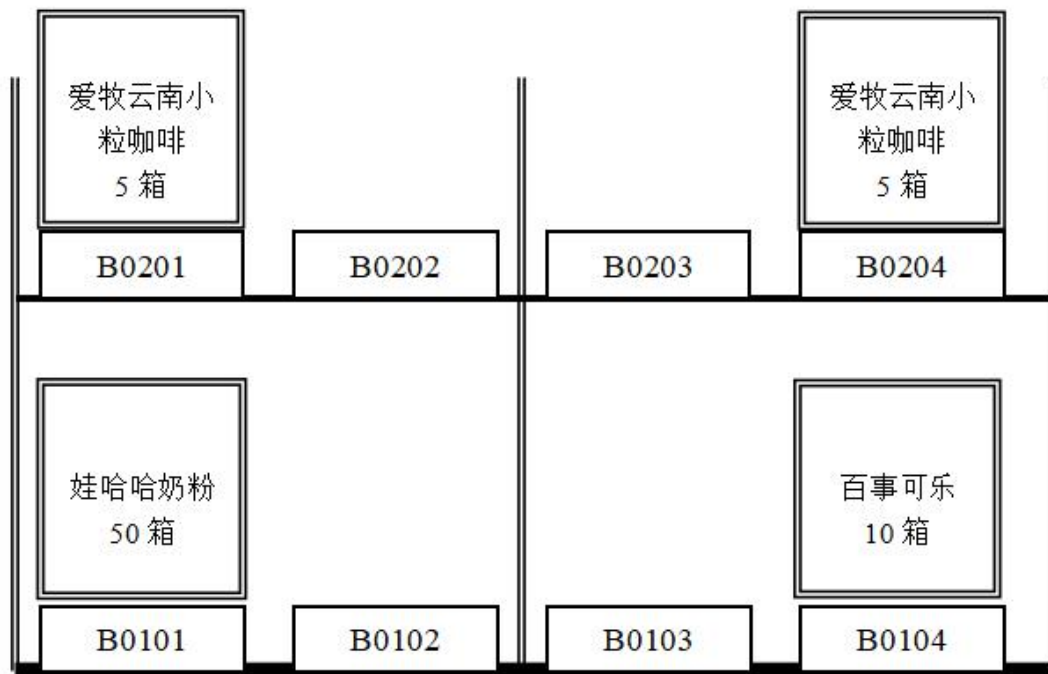
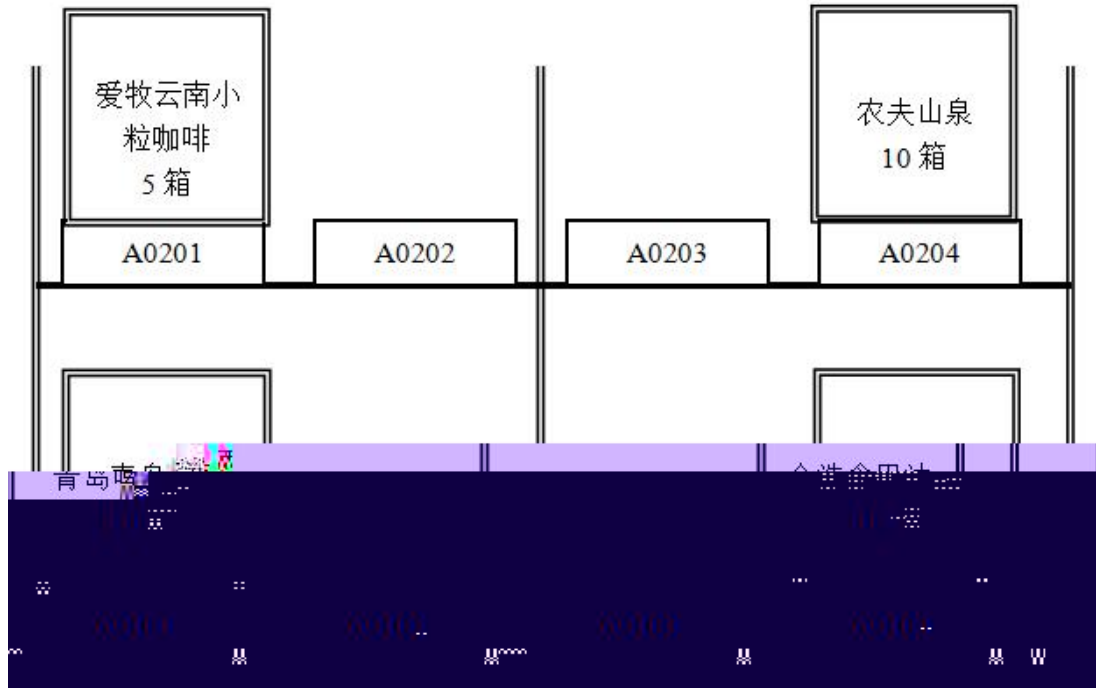

X

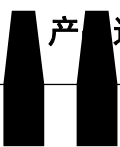

产 运输

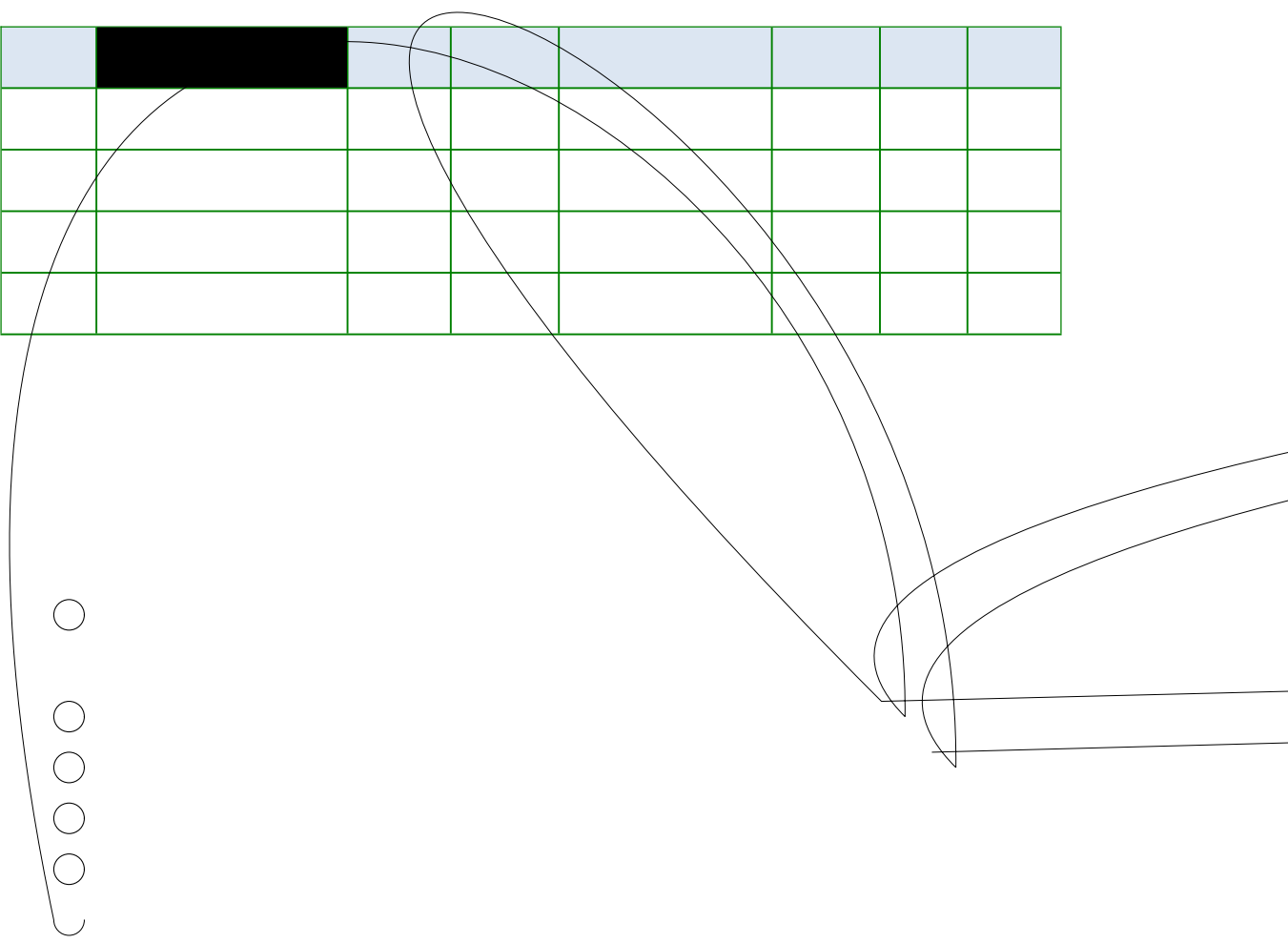

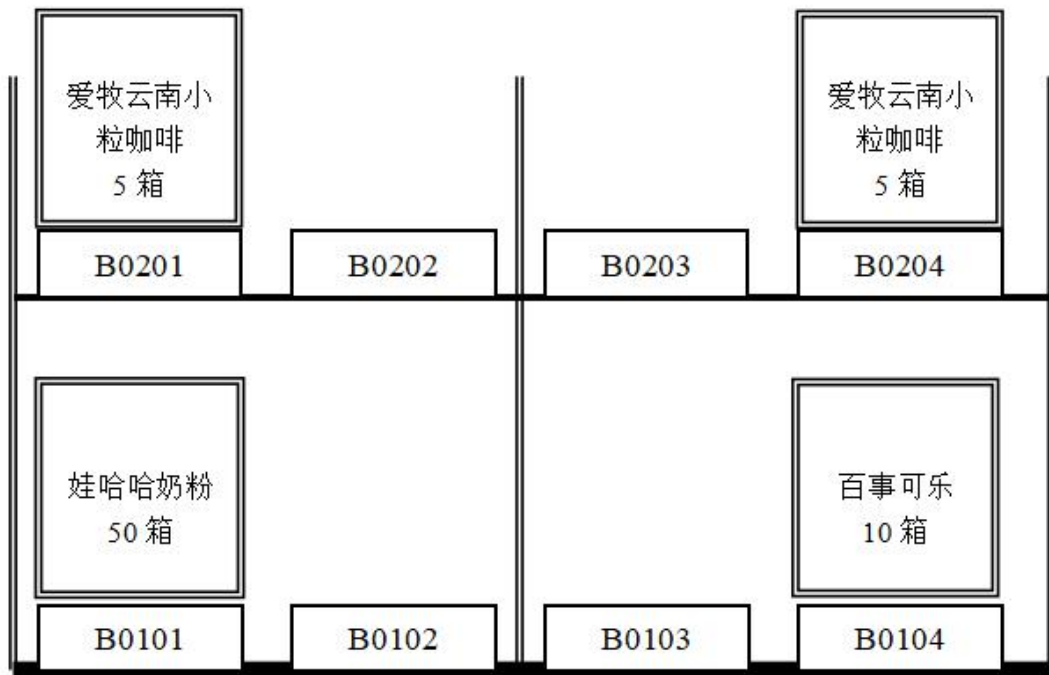
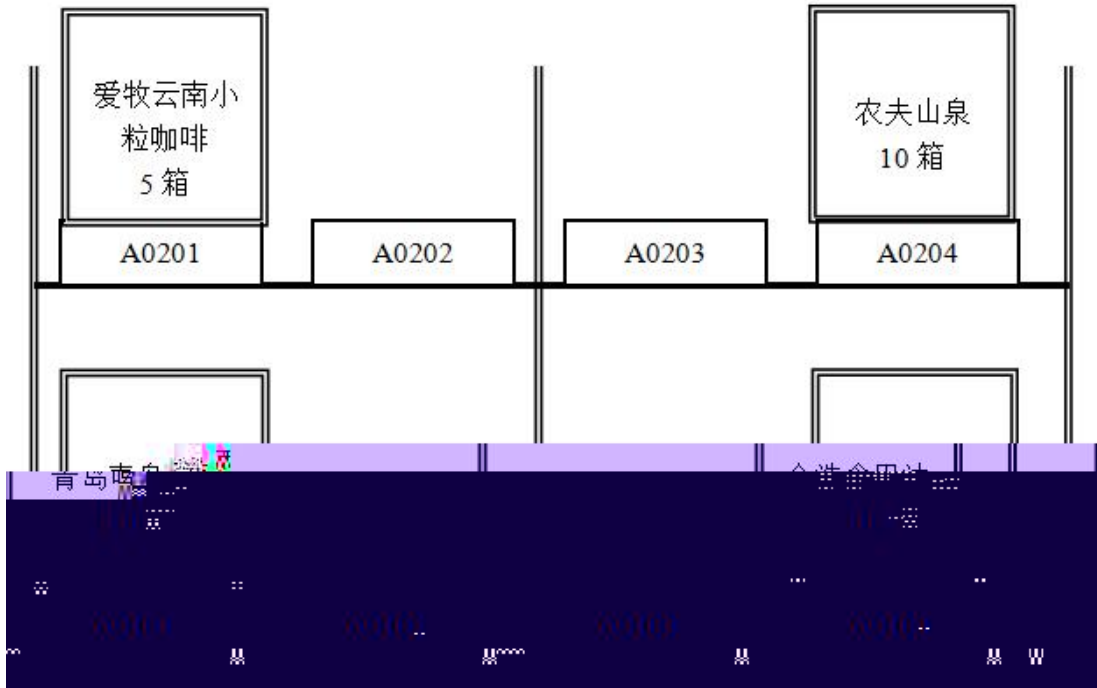

产品运输单

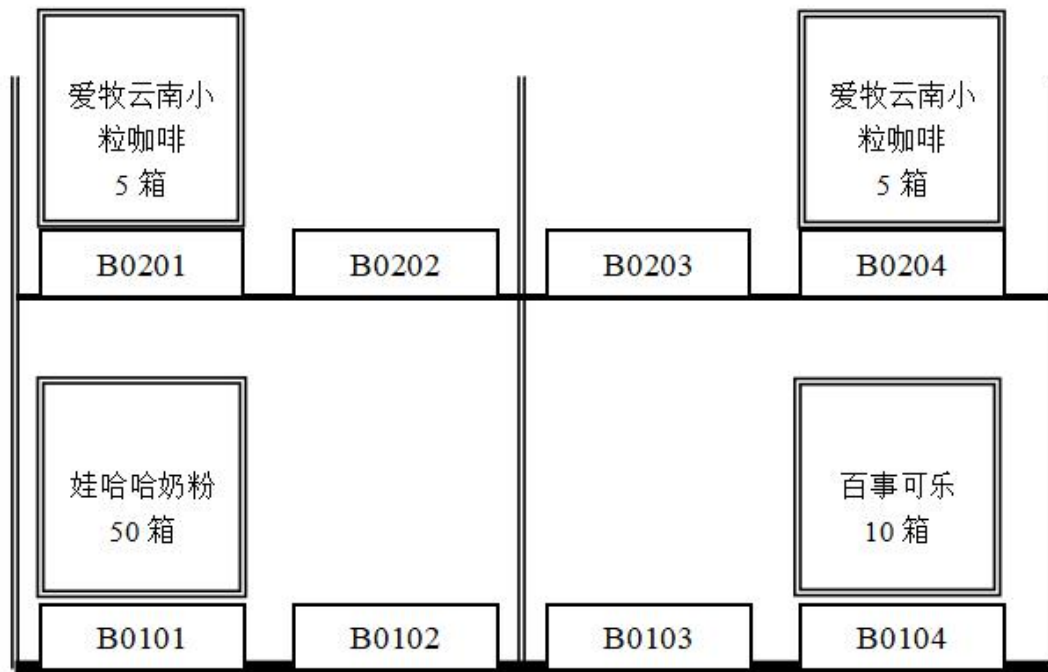
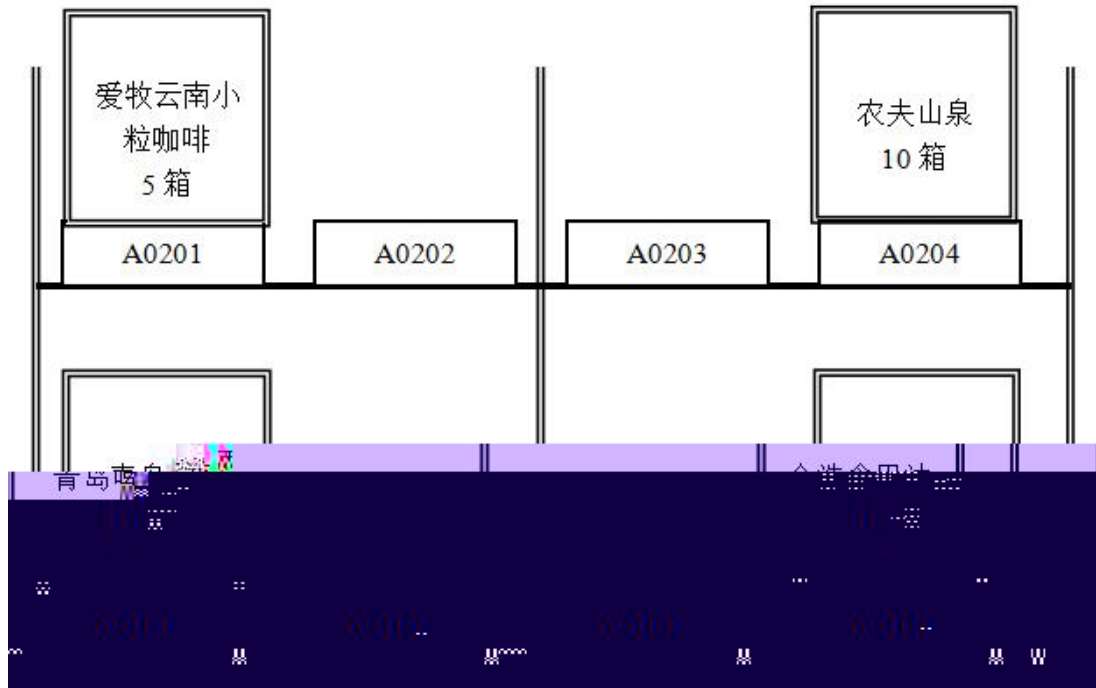

产品运输单

-
-
-
-
-
-
-
-
-

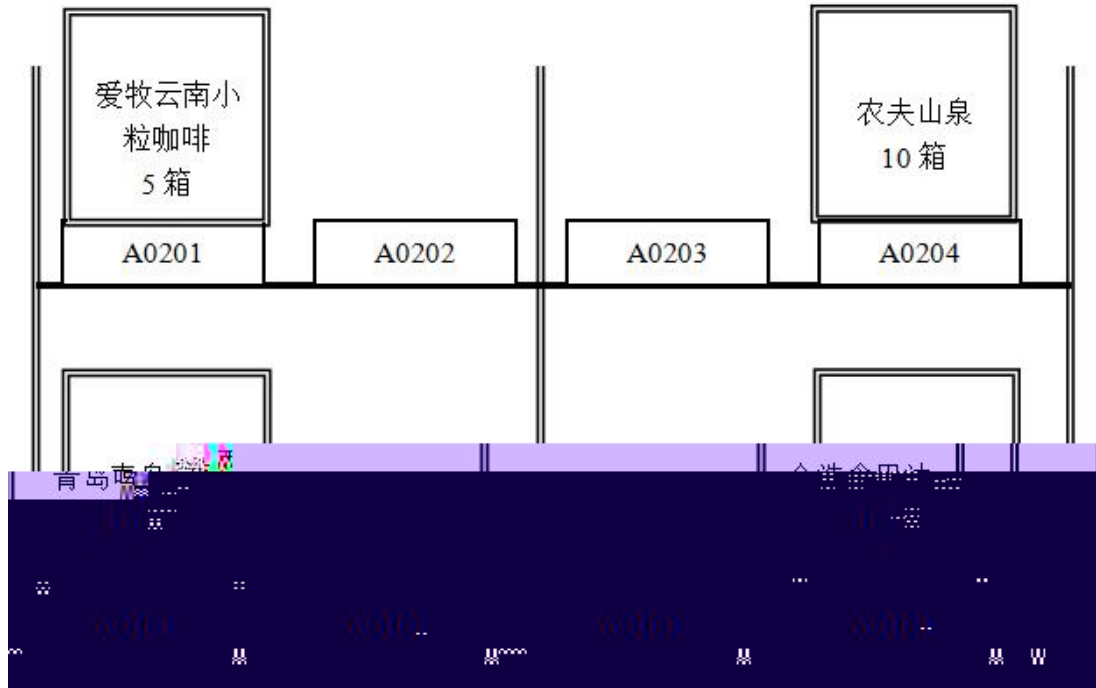

产品运输单

-
-
-
-
-
-
-
-
-

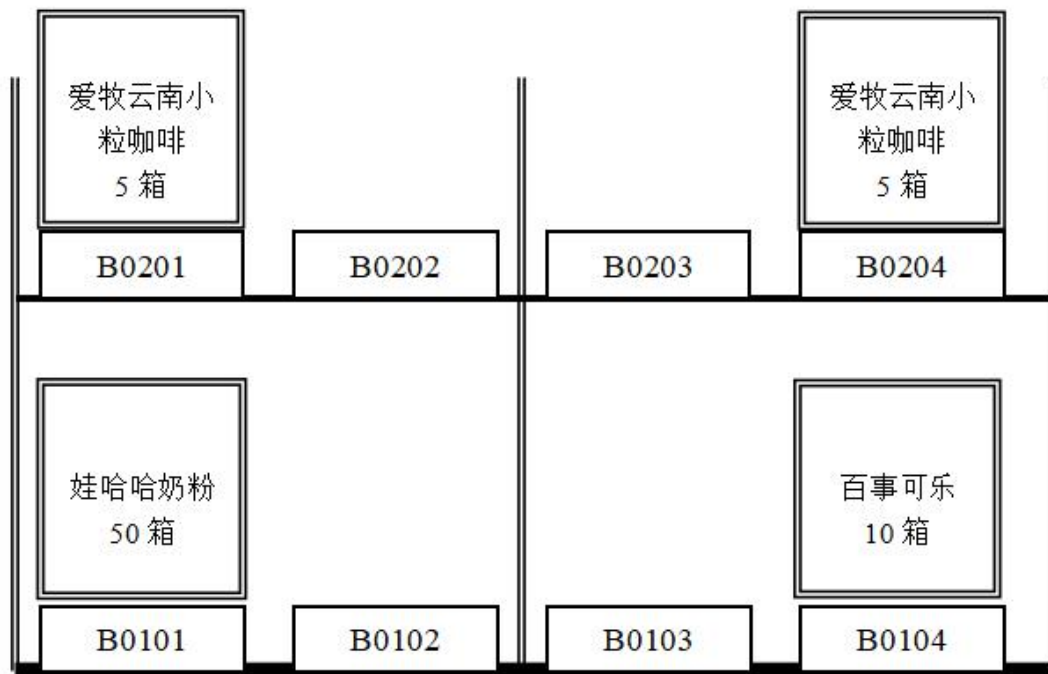
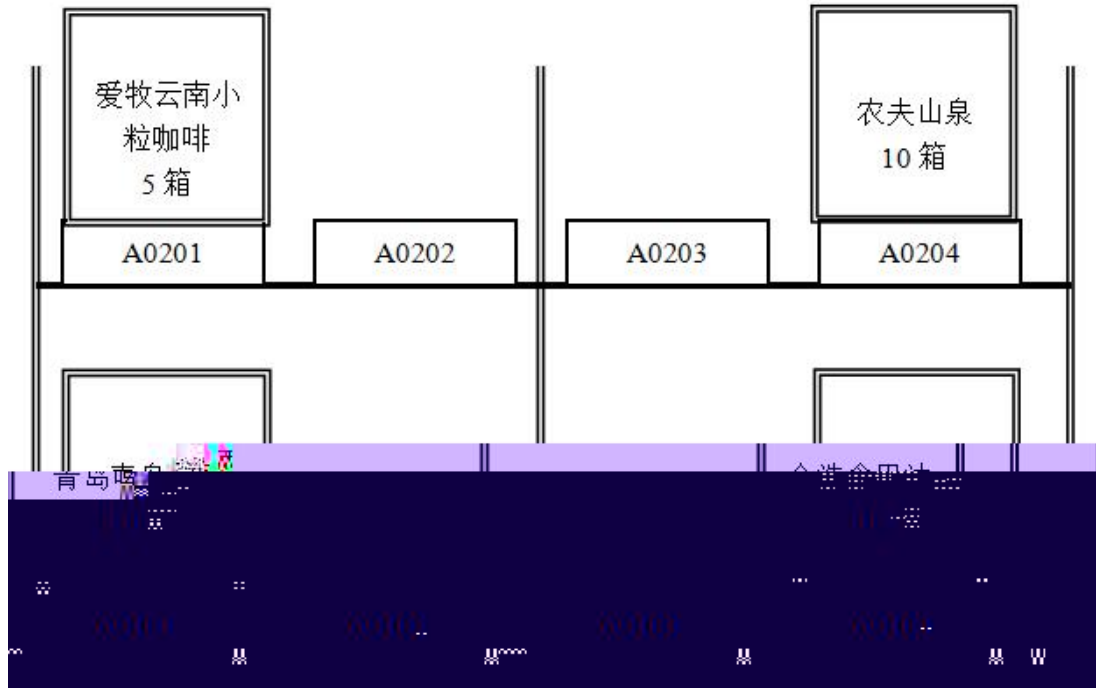

产品运输单

-
-
-
-
-
-
-
-

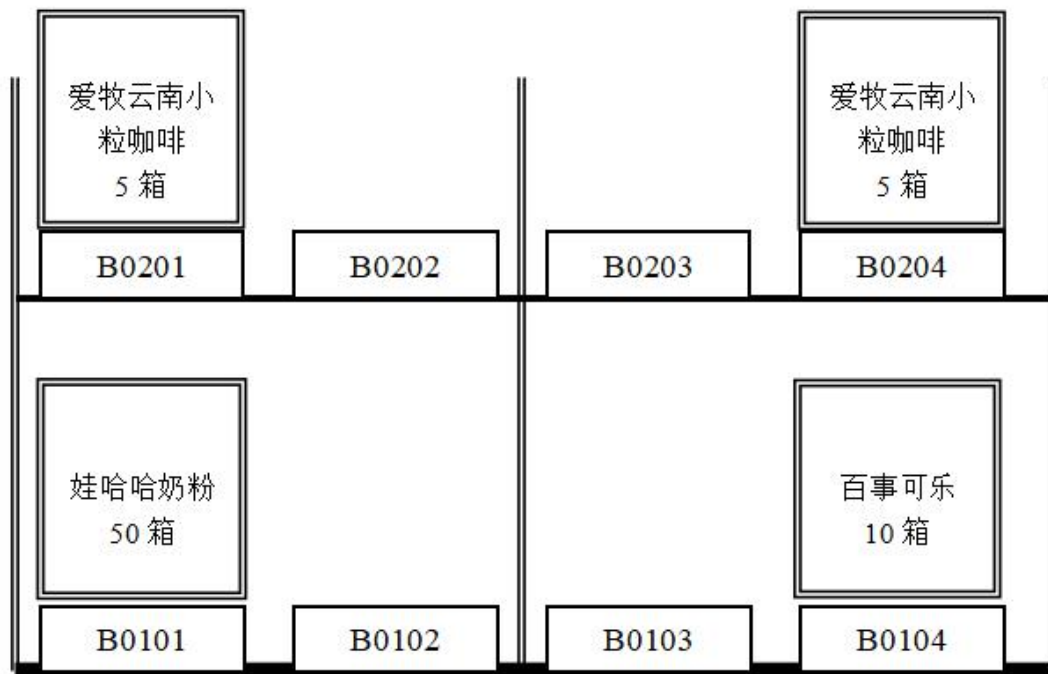
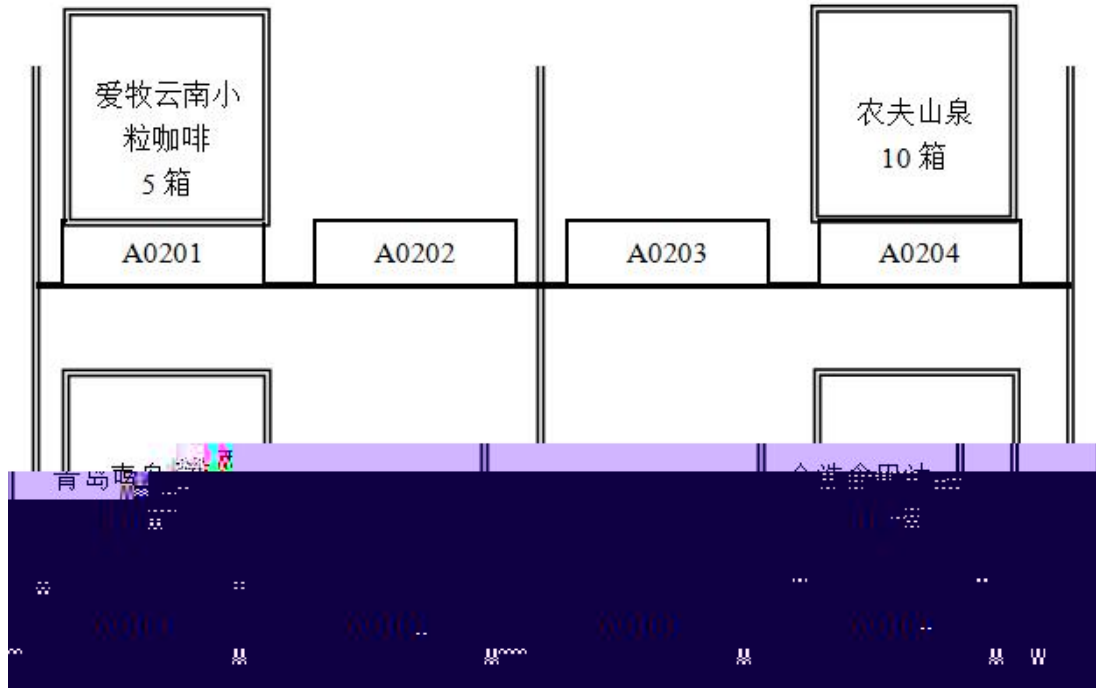

产品运输单

-
-
-
-
-
-
-
-

○

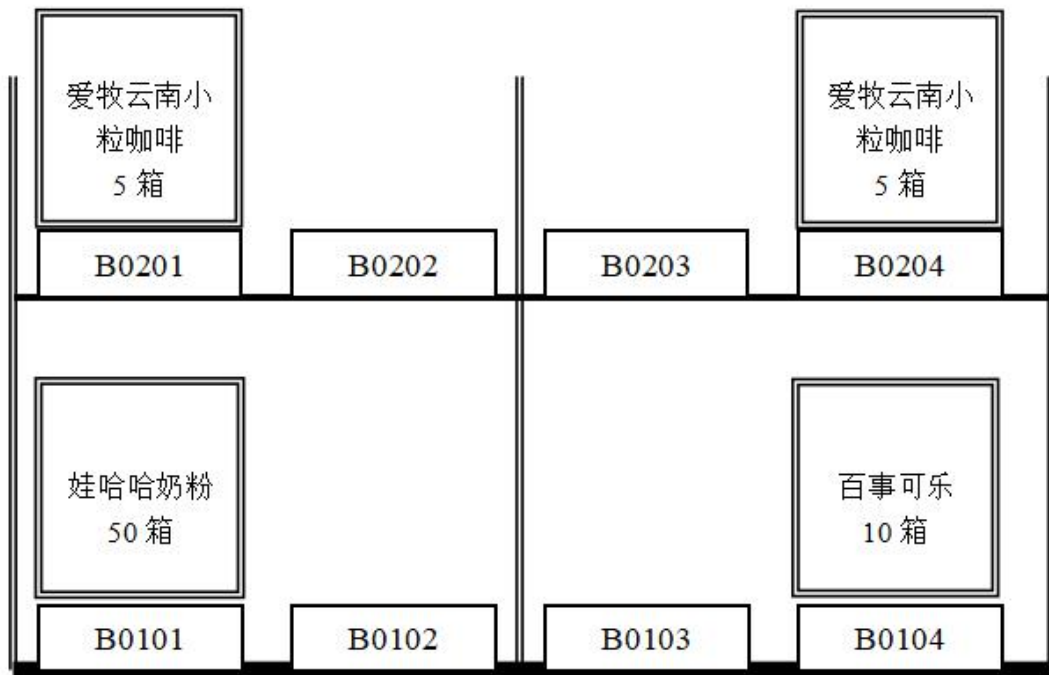
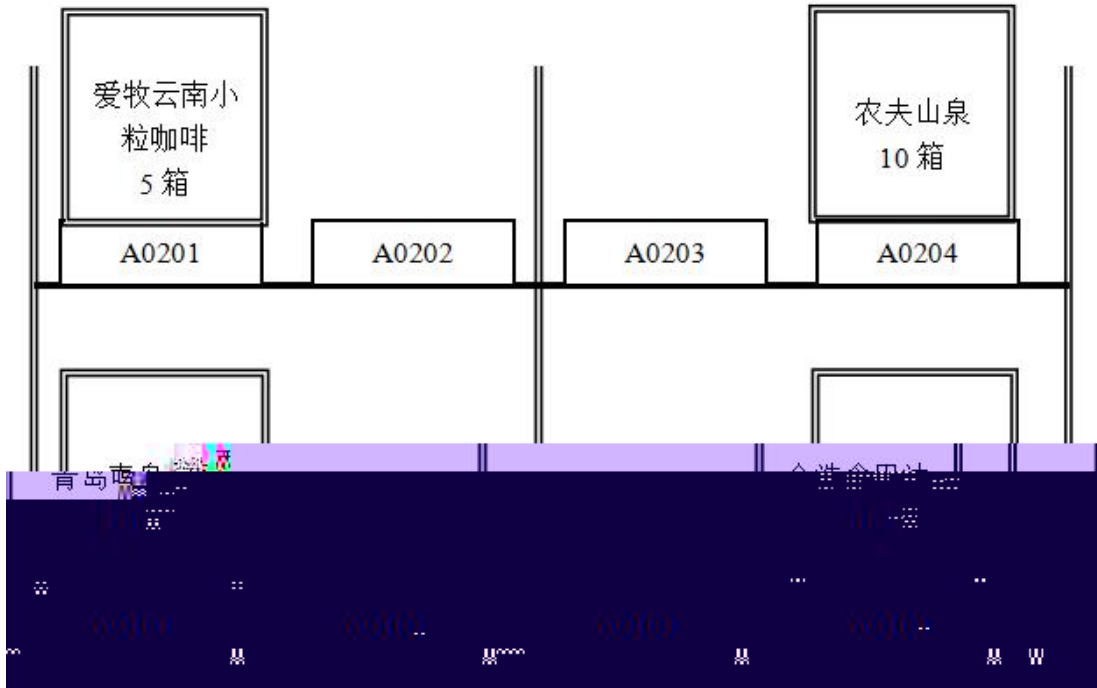



--	--	--	--	--	--

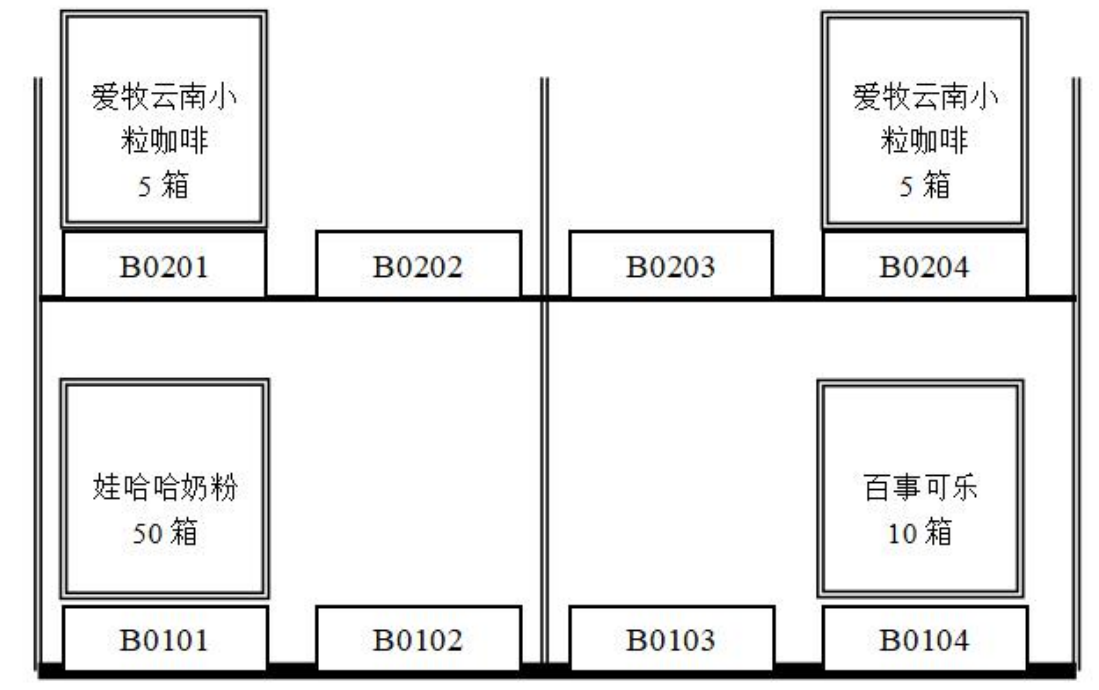
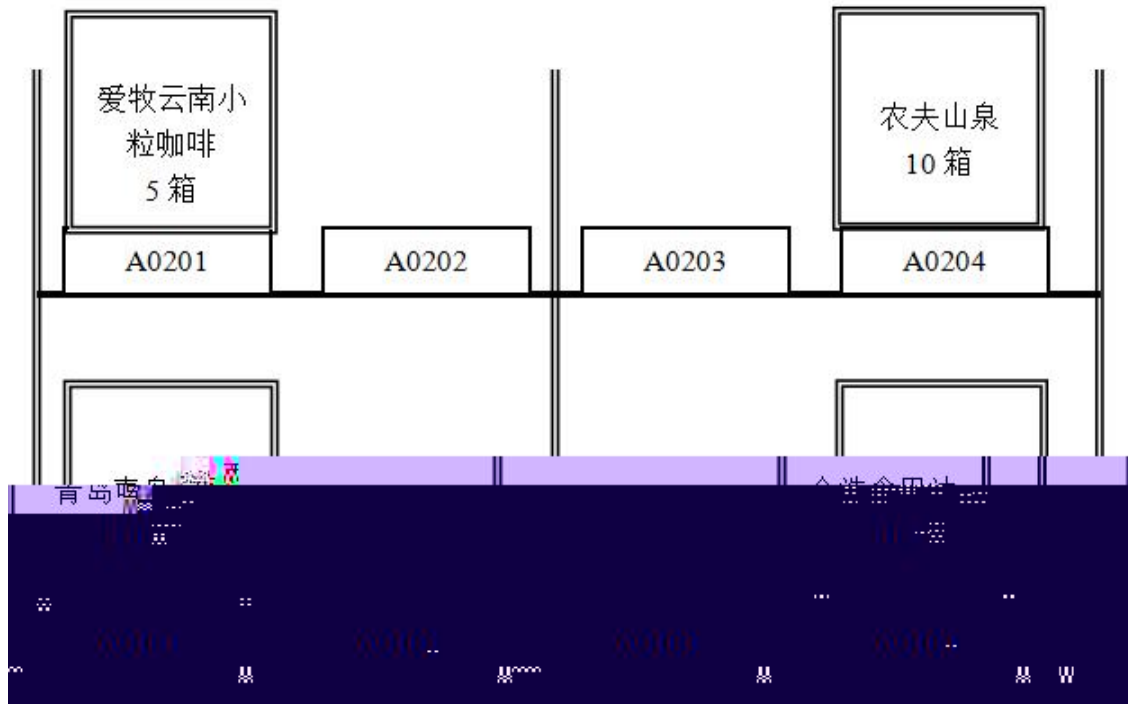

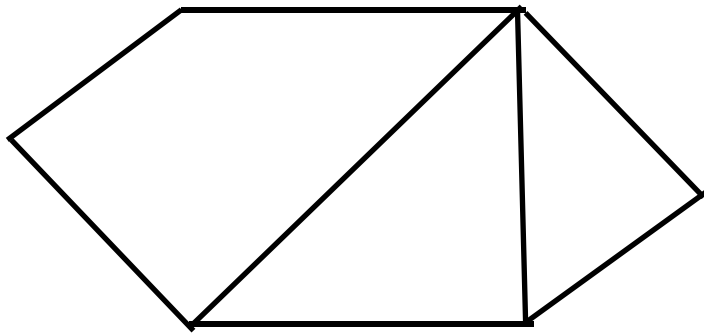



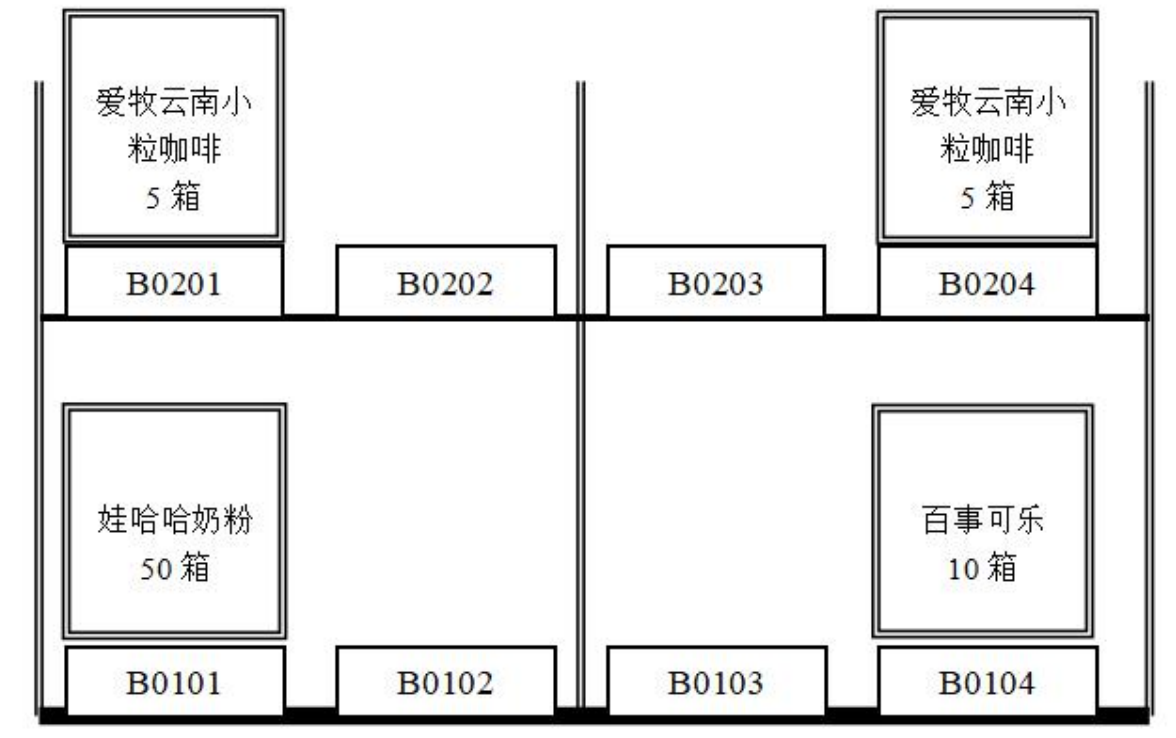
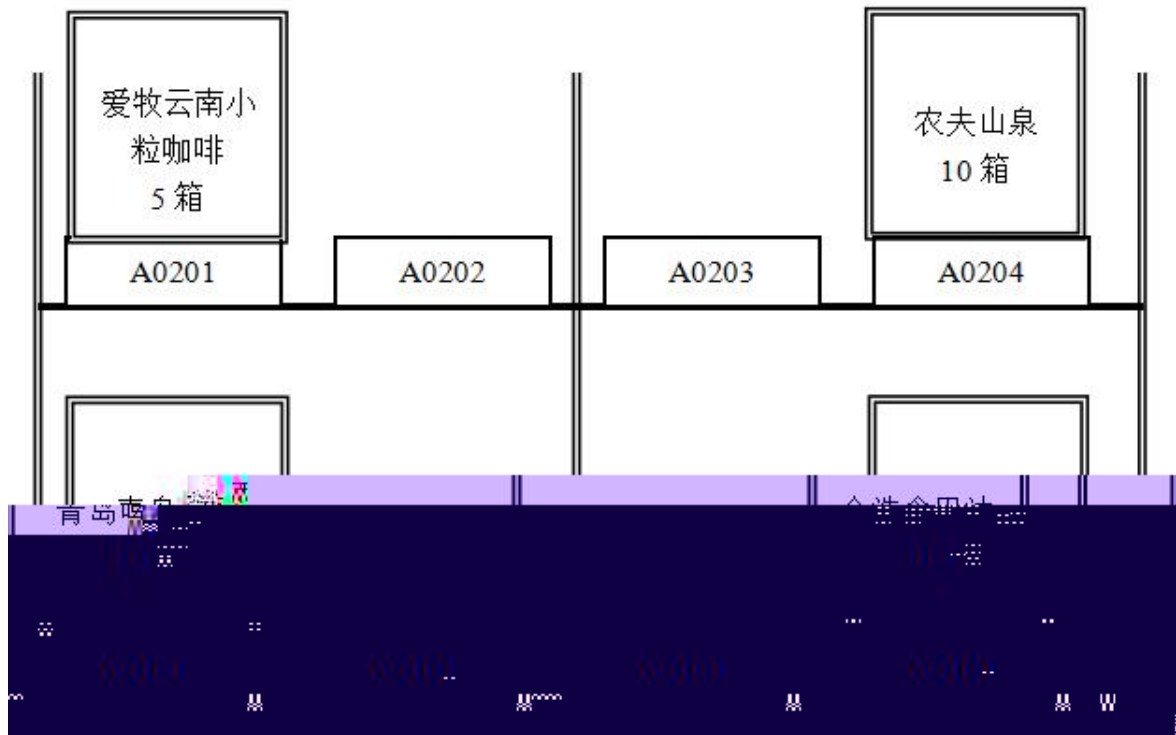

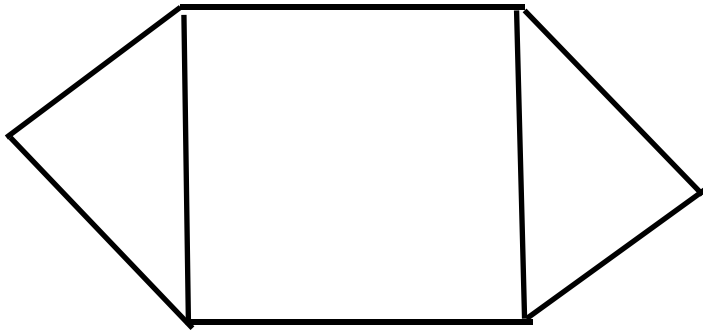

1

		---	---		

		---	---		

--	--

--- ---

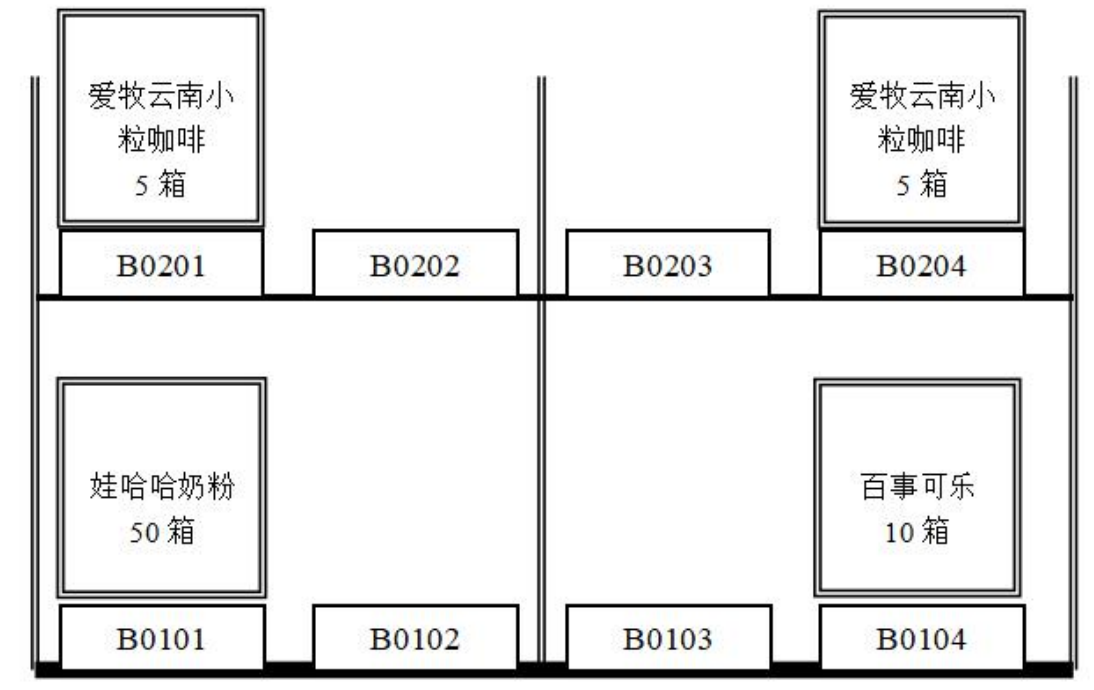
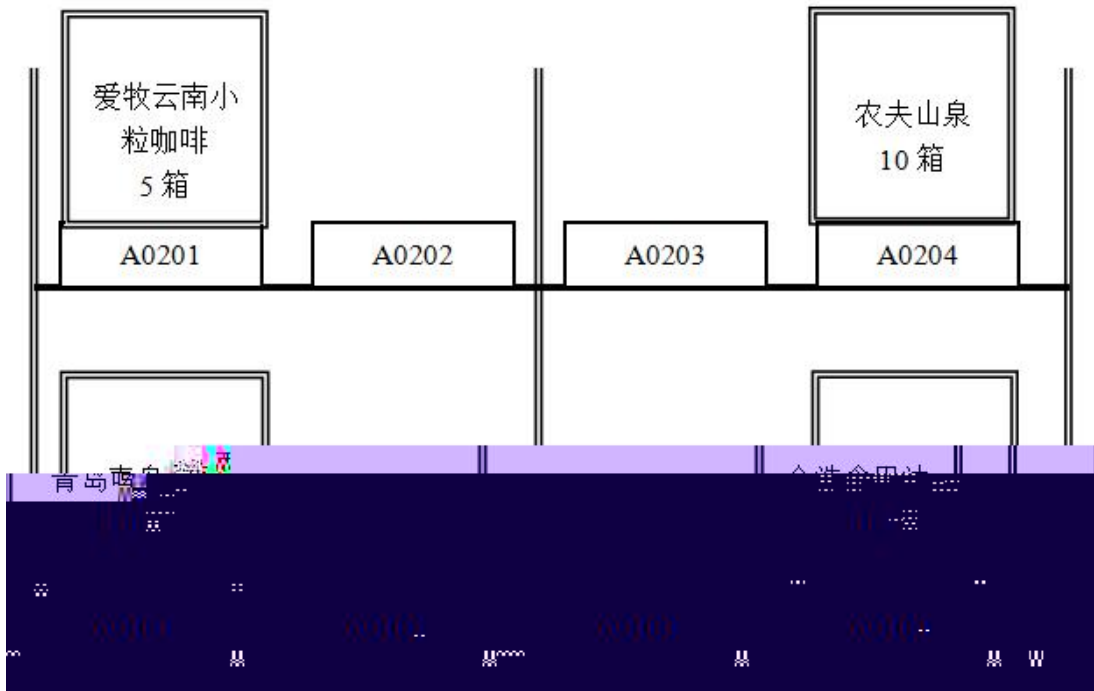

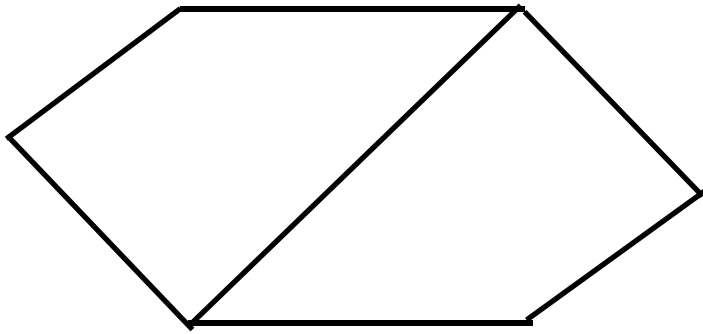

1

--	--	--	--	--	--

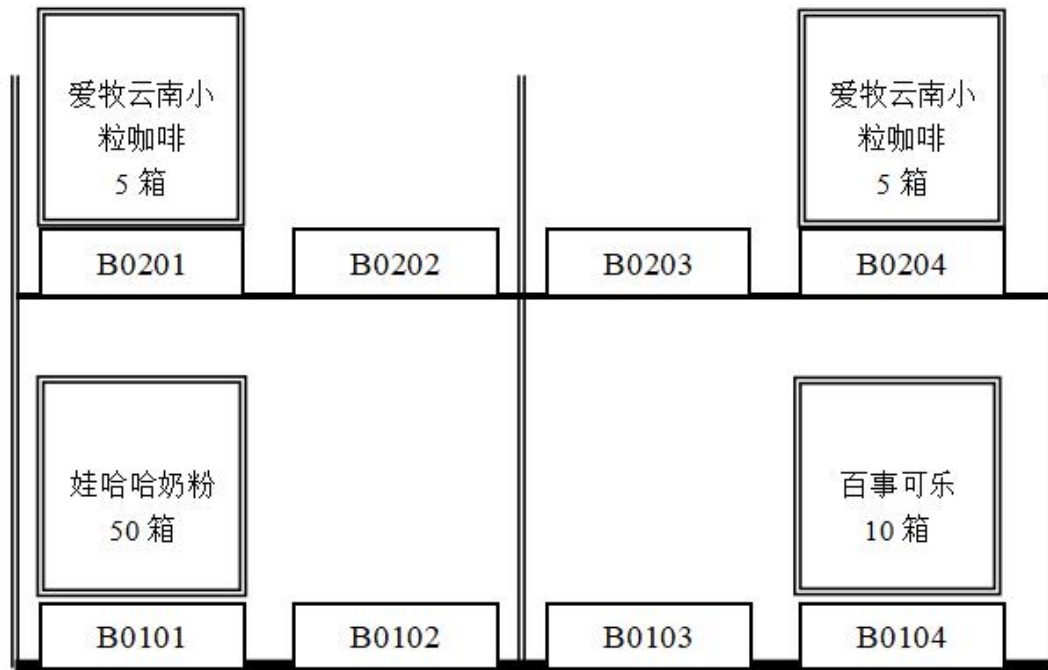
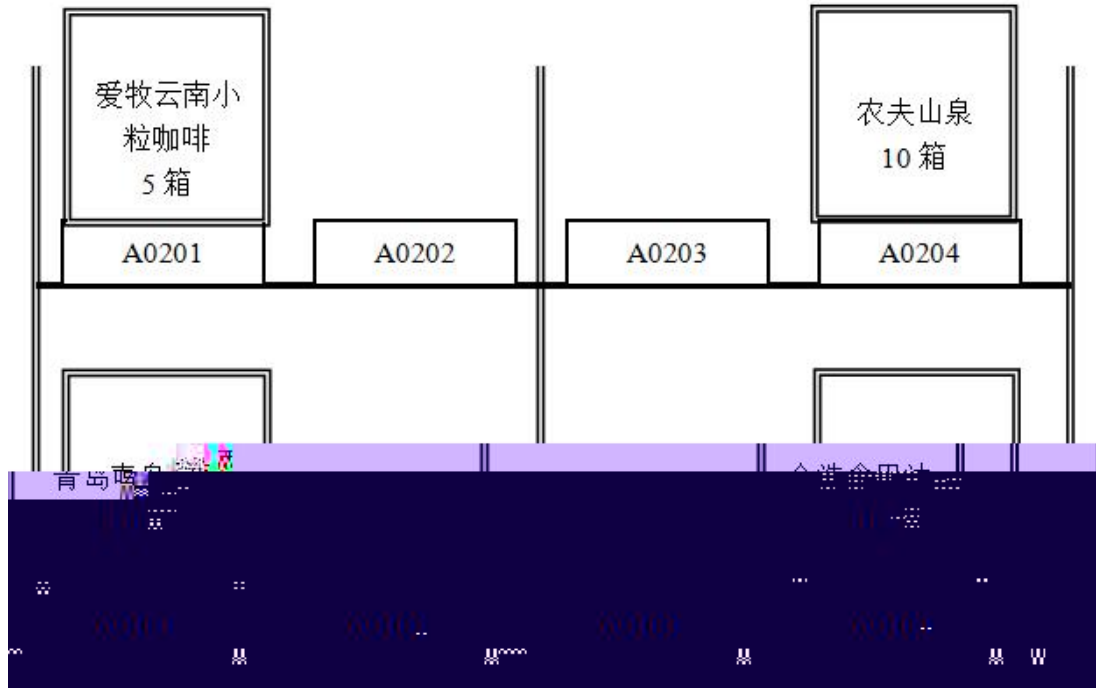

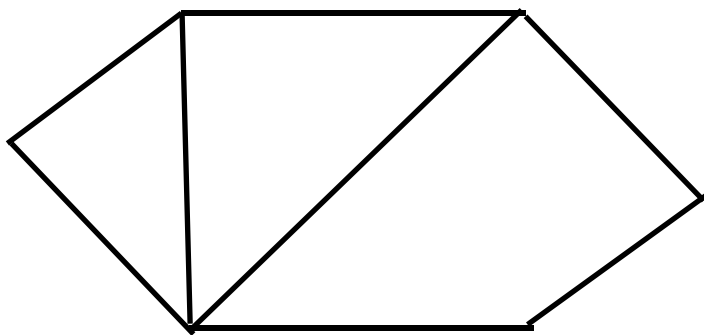

○

○

○

○

○

○

○

○

--	--

○

○

三、国际物流作业组织与管理模块

○

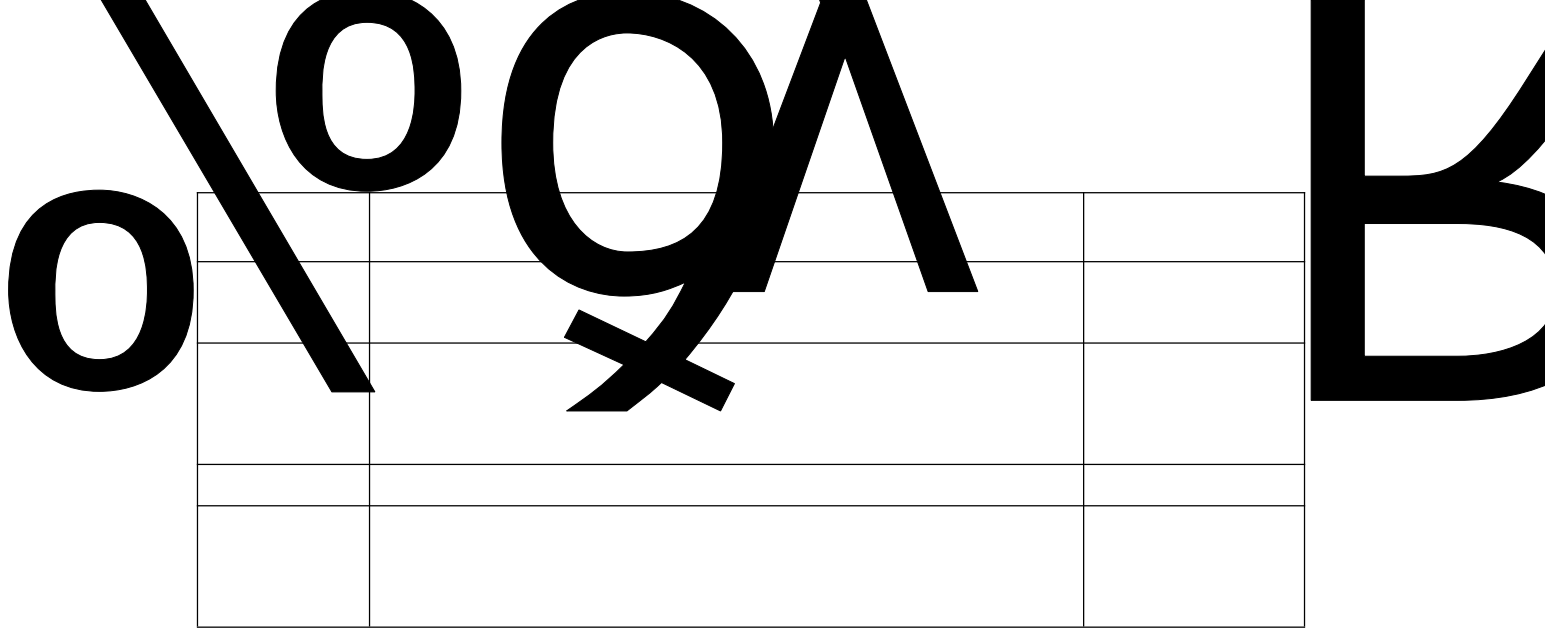

A6

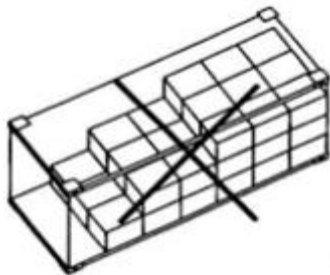
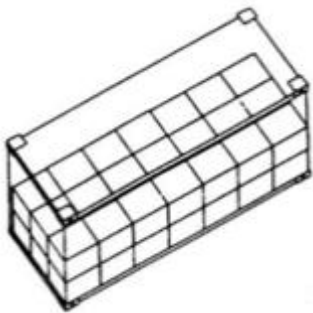

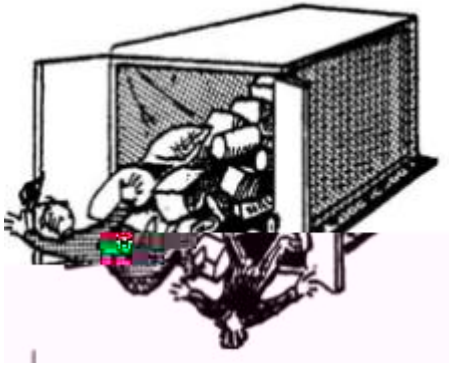
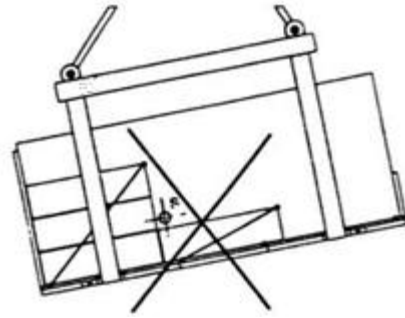

○

船公司	船名/航次	服务代码	航线	装船港/卸船港	启-达日期	天	挂港
Carrier	Ship/Voy	Service Code	Lane	Load/Unload Port	ETD-ETA	Day	Port
船公司	MSC 地中海航运	MASTER S/409E	中国-香港台	HONG KONG 香港 KAOHSIUNG 高雄	02/25(二) 03/15(六)		18
船公司	NYK 日本邮船	ITALIAN EXPRES S/024	中国-东南亚	HONG KONG 香港 BANGKOK 曼谷	02/25(二) 03/02(日)		5
船公司	CMA-CGM 达飞轮船	CMA CGM GEMINI IXA49E	中国-非洲	XIAMEN 厦门 DURBAN 德班	02/25(二) 03/27(四)		30
船公司	KLINE 川崎汽船	HYUNDAI PLATINU M/004E	中国-中南美	SHANGHAI 上海 PARANAGUA 巴拉那瓜	02/25(二) 04/09(三)		43
船公司	DMS 达茂轮船	COSCO KAOHSIUNG G/GFS46E	中国-澳新	HONG KONG 香港 NOUMEA 努美阿	02/25(二) 04/02(三)		36
船公司	RCL 爱海轮运	ROTA PERMASAN VPM114	中国-中东/ 波斯湾/印巴	QINGDAO 青岛 MADRAS 马德拉斯	02/28(五) 03/18(二)		18
船公司	ZIM 以星轮船	KUO HUNG 311	CHINA_VIETN AM(CVX)	NINGBO 宁波 HONG KONG 香港	02/25(二) 03/15(六)		18
船公司	SAPMARINE 比利时报航	HEIKO P 1404	中国-非洲	KAOHSIUNG 高雄 MINDELO	02/25(二) 04/05(六)		39
船公司	CSAV 长荣轮船	CAP SAN NICOLA S/01409	中国-中南美	SHANGHAI 上海 RIO GRANDE 里奥格兰德	02/25(二) 04/07(一)		41
船公司	OOCL 东方海外	DRESDEN EXPRES S/16808	Pacific Atl antic (PAX)	SHANGHAI 上海 HALIFAX 哈利法克斯	02/25(二) 04/14(一)		48

○
○

BEIJING	CN		BJ\$
Y. RENMINBI	CNY		KGS
BOSTON	US	M	630.00
		N	79.97
		45	60.16
		100	53.19
		300	45.80

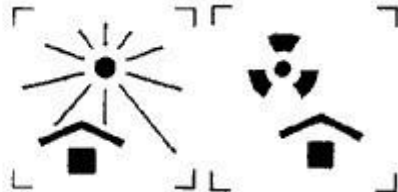
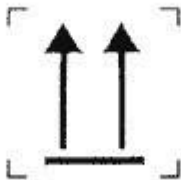
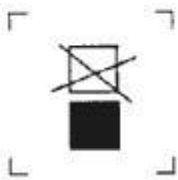

○













○

○

集装箱设备交接单
EQUIPMENT INTERCHANGE RECEIPT

OUT 出场

No.

用箱人/运箱人(CNTR. USER/HAULIER)			提箱地点(PLACE OF DELIVERY)		
发往地点(DELIVERED TO)			返回/收箱地点(PLACE OF RETURN)		
船名/航次(VESSEL/VOYAGE No.)		集装箱号(CNTR. No.)		尺寸/类型(SIZE/TYPE)	
提单号(B/L No.)		危险品类别(IMCO CLASS)		箱封号(SEAL No.)	
货重(CARGO W.)		出场目的/状态(PPS OF GATE-OUT/STATUS)		进场目的/状态(PPS OF GATE-IN/STATUS)	
				出箱日期(TIME-OUT) 月 日 时	
出箱检查记录(INSPECTION AT THE TIME OF INTERCHANGE)					
普通集装箱(GP. CNTR.)		冷藏集装箱(REF. CNTR.)		特种集装箱(SPL. CNTR.)	
<input type="checkbox"/> 正常(SOUND) <input type="checkbox"/> 异常(DEFFECTIVE)		<input type="checkbox"/> 正常(SOUND) 设备状态(SET) <input type="checkbox"/> 异常(DEFFECTIVE) 记录状态(RECORDED)		<input type="checkbox"/> 正常(SOUND) <input type="checkbox"/> 异常(DEFFECTIVE)	
<input type="checkbox"/> 发电机(GEN. SET) <input type="checkbox"/> 正常(SOUND) <input type="checkbox"/> 异常(DEFFECTIVE)					
箱体记录及代号(DA)					
<div style="display: flex; justify-content: space-around;"> <div style="text-align: center;">  破损 (BROKEN) </div> <div style="text-align: center;">  凹痕 (DENT) </div> <div style="text-align: center;">  丢失 (MISSING) </div> <div style="text-align: center;">  污损 (DIRTY) </div> <div style="text-align: center;">  玻璃 (GLASS) </div> </div>					
左面 (LEFT SIDE)		右面 (RIGHT SIDE)		前面 (FRONT)	
后面 (TOP)		底部 (FLOOR BASE)		后面 (REAR)	
					
					
内部 (INSIDE) 如有异常, 请注明程度及尺寸 (REMARK)					
					
除列明者外, 集装箱设备交接时完好无损, 密封完整。 * CONTAINER EQUIPMENT INTERCHANGED IN SOUND CONDITION AND SEAL INTACT UNLESS OTHERWISE STATED					
用箱人/运箱人签署 (CONTAINER USER/HAULIER'S SIGNATURE)			码头/堆场设备员签署 (TERMINAL/DEPOT CLEER'S SIGNATURE)		
_____ 年 ____ 月 ____ 日			_____ 年 ____ 月 ____ 日		



--	--	--	--	--	--

--	--	--

--	--	--	--	--	--

--	--	--	--	--	--

--	--	--	--	--	--	--	--

○



○

--	--	--

--	--	--	--	--	--

○

○

○

○

四、 快递物流作业组织与管理模块

--	--	--	--	--	--

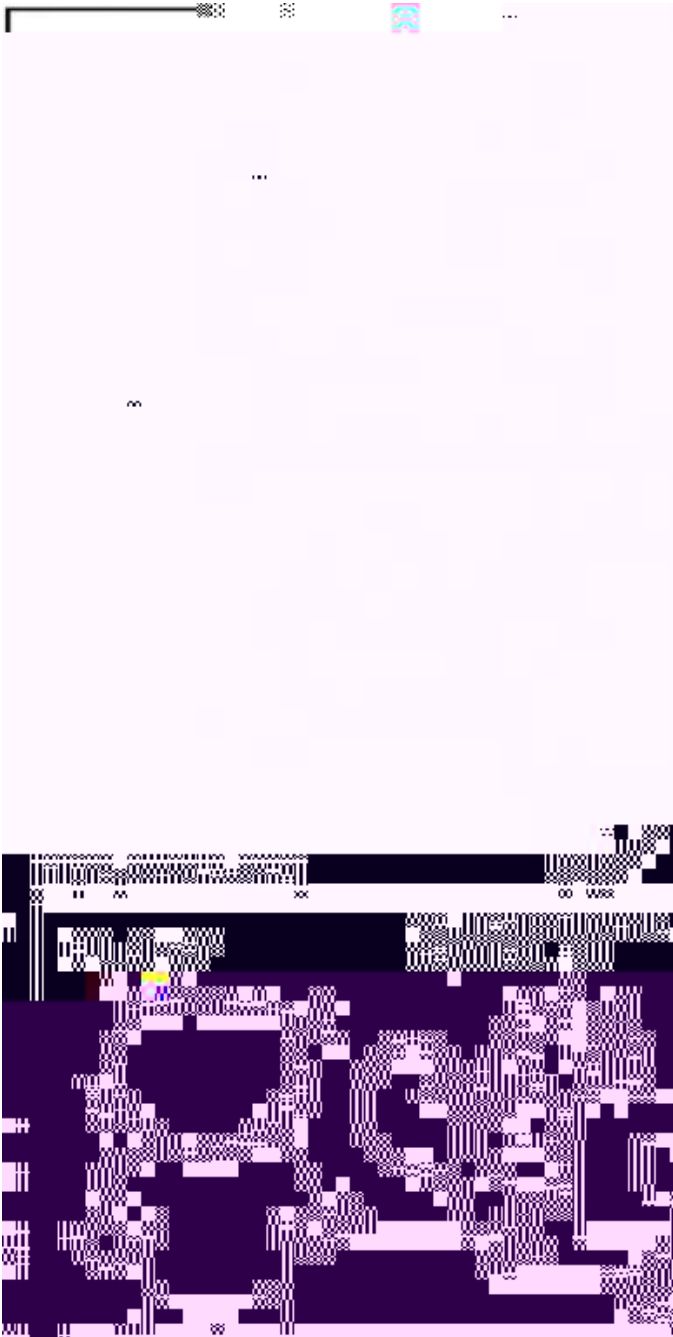

出示身份证件实名信息录入，确保信息安全

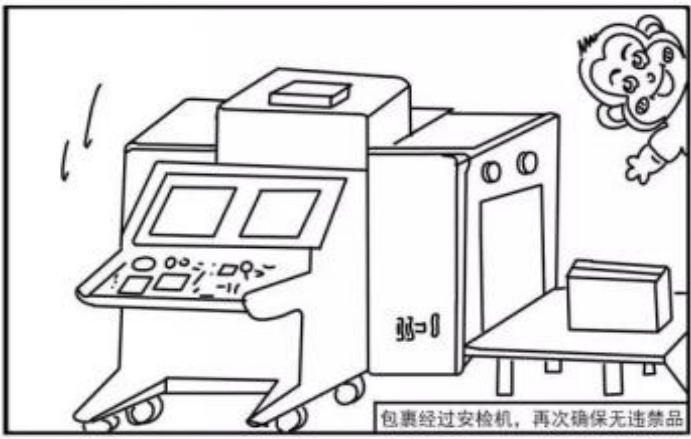

包裹经过安检机，再次确保无违禁品



宅急送，致力于成为中国最有价值的综合物流服务商

--	--	--	--	--	--

@

--	--	--	--	--	--

[想知道:中国成都理工大学校园快递具体在哪? 百度知道](#)

3个回答 - 提问时间: 2014年02月10日

最佳答案:  均在银杏后面。宝盒、圆通、顺丰在电影院后面。中通、申通在图书馆下面。常用的是这几个。

zhidao.baidu.com/link?... 2014-02-15 - 百度快照 - 80%好评

--	--	--	--

--	--	--	--

1

<hr/>
